



JPEG XS In Action !







Xilinx FPGA reference platform with Adeas/Nextera ST2110/2059 & NMOS cores combined with intoPIX TicoXS ST2110-22 cores

The IPMX/ST2110-22 design transports 4Kp60 444 over 1-Gb combine intoPIX TicoXS Encoder/Decoder & RTP packetizers cores with Adeas/Nextera ST2110/2059 & NMOS cores, running on a Xilinx FPGA reference platform.

- Design with intoPIX codec cores + Adeas/Nextera SMPTE ST 2110/2059 and NMOS cores.
- Ease equipment manufacturers to add IPMX (or IP) capabilities to their products quickly and easily.





Appear, Mobilelinks and Cosm deployed JPEG XS encoding for 3D VR content delivery at major sporting events

JPEG XS provided the basis for the successful delivery of live VR content for the event's beginning and ending shows, as well as for live 3D VR content across five major sporting events, including boxing, basketball, beach volleyball, gymnastics, and athletics. This live VR content was delivered three times, every day throughout the entirety of the event.

- Flexible and reliable solution supporting JPEG XS and SMPTE ST 2110 in a fully redundant network.
- Compression of live video feeds at a lossless rate to ensure transmission with minimal latency.
- Bridged classic coax infrastructure with new sites based on SMPTE 2110.
- Compact hardware for outside and live event production.

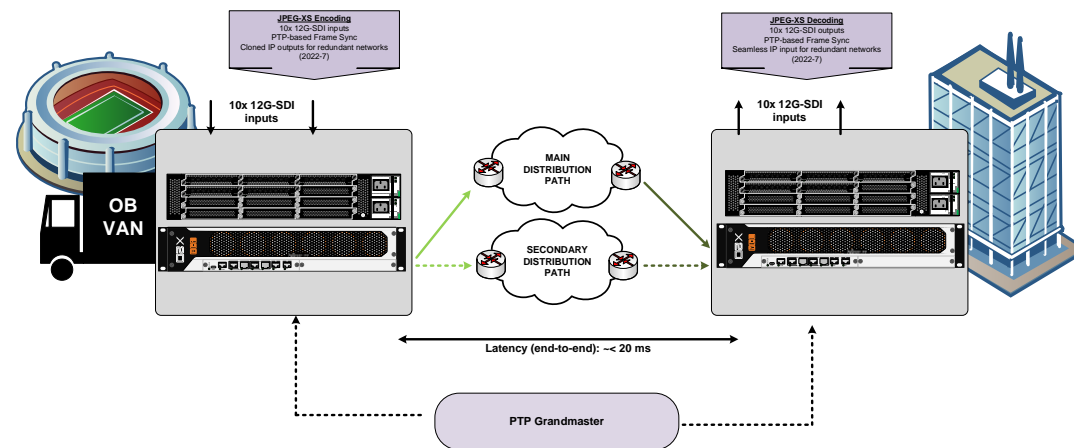

Shortlisted for the Best remote production category at the CSI Award 2022.



Booth : 1.C61



4K contribution with JPEG XS TS for a major football league

JPEG XS and JPEG XS ST2110 to encode multiple 4K channels during sport live event.

- Powerful encoding capabilities: UHD ready, HEVC 4:2:2, low and ultra-low latency.
- High density.
- Combined encoding and decoding function.
- Eliminate interconnected equipment with no-single-point-of-failure architecture.
- Video alignment feature for H.263.
- PTP-based Frame-sync for 2110 transmissions.

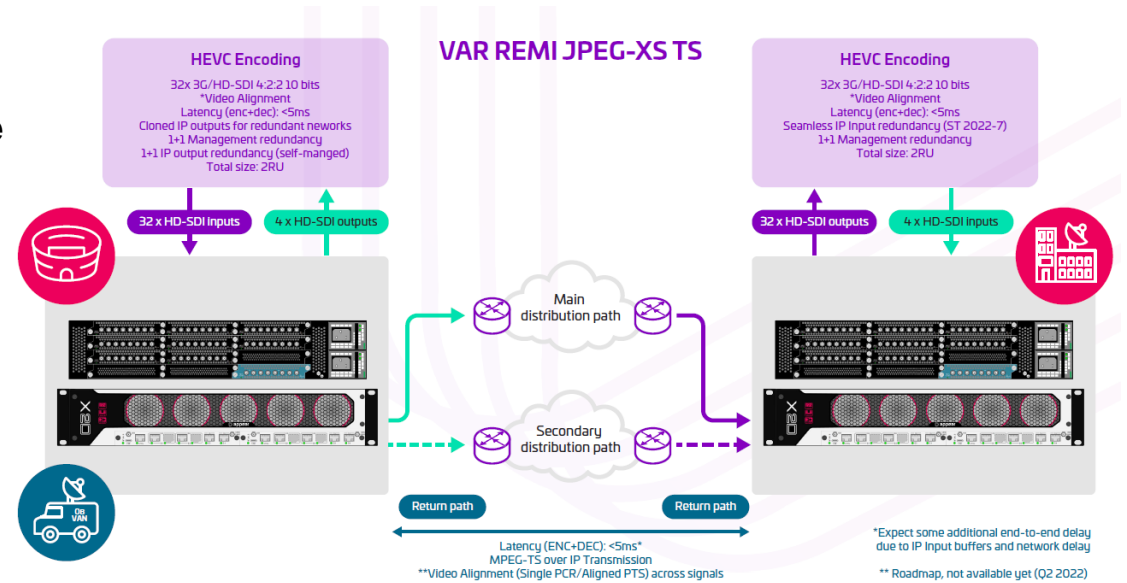

Booth : 1.C61

BLADE//runner JXS – JPEG XS Encode/Decode app

arkona BLADE//runner JXS is a software application for the AT300 that provides 8 instances of ST2110-22 JPEG XS codecs. All 8 codecs are either configured as encode OR decode but can be changed on demand.

In addition, the JXS app provides uncompressed gateway capabilities with 2110-20, 30/31, and 40 encapsulation/de-encapsulation as well as routing/shuffling and delay/sync capabilities.

- Up to 64 UHD encoders/decoders in 3RU.
- Up to 16 UHD encoders/decoders in 1RU.
- ST2110-22 standards compliant.
- In active deployment by major live broadcast service providers.

BLADE//Runner



Booth : 9.C01



SMART openGear

SMART openGear® is a software-defined 12G/3G/HD/SD-SDI-over-IP multifunction gateway.

- VSF J2K TR-01, JXS TR-07, and JXS SMPTE 2110-22 TR-08.
- Autosensing.
- Software Defined.
- 4 channels.

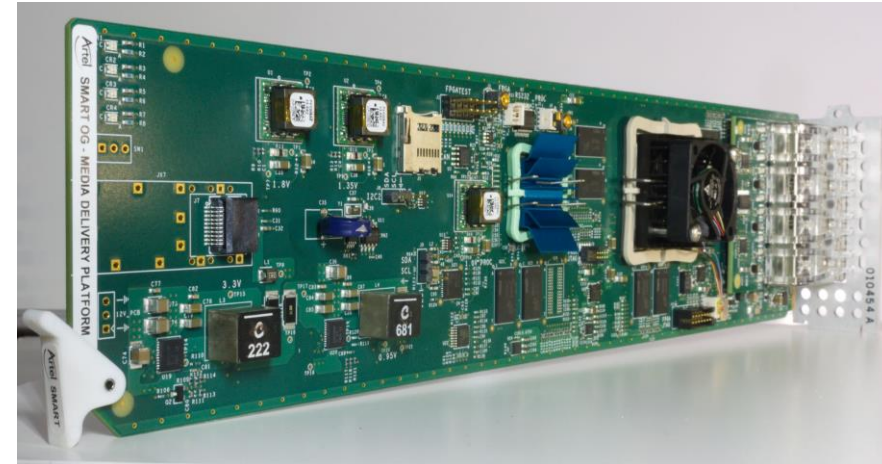



AWS Elemental Live and AWS Elemental MediaConnect JPEG XS for low-latency, visually lossless contribution & production to the cloud

AWS Elemental Live makes it simple to ingest/decode and output/encode to the JPEG XS standard. Encode and the decode functions follow the SMPTE ST 2110-22 specification for compressed video transport with support for NMOS. AWS Elemental MediaConnect receives these streams in an AWS Region and converts them to uncompressed video (using CDI, Cloud Digital Interface) for low latency, high video quality workflows.

- JPEG XS for LIVE PRODUCTION into the CLOUD with MediaConnect.
- Direct interface to AWS CDI.
- Premium quality | Minimal latency.

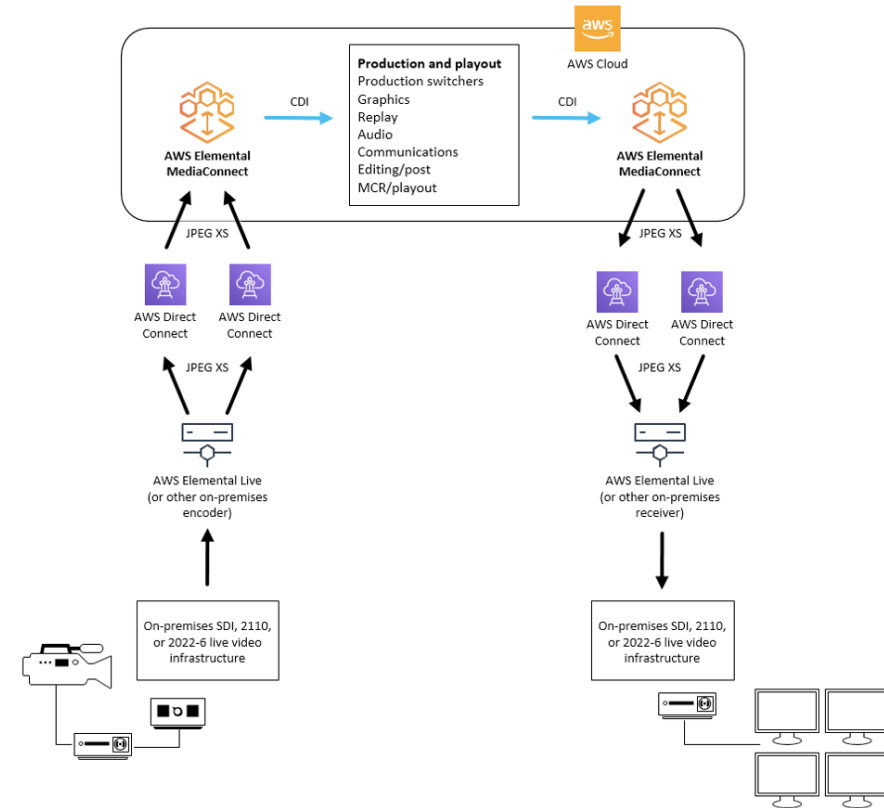

Booth : 5.C90



BBright UHD-Decode with ST2110-22 / JPEG XS

UHD-Decode is a universal (JXS / HEVC / H264 / MPEG2 / J2K) multichannel contribution and monitoring decoder designed for professional Broadcast applications such as for satellite, terrestrial, cable, OTT operators and IPTV networks.

- Adjustable JPEG XS bandwidth.
- Transport Stream over IP, SRT, and ASI input support.
- Up to 8 decoding channels with EVC / H264 / MPEG2 & J2K support.
- UHD & HDR ready, and support for Dolby DD/DD+/Atmos/AC4/ED2 & Vision.



Booth : 2.B39b



VB440 Production Probe

Integration of JPEG XS compression analysis into the VB440 cements the position of the probe as an integral component of core broadcasting networks, production studios, master control centers, and outside broadcast vehicles and venues, future-proofing it so that broadcasters can continue to reap the benefits of advanced monitoring and insight even as they adopt new network standards.

- Broadcasters can ensure reliable, high-level ST2110 streams, from anywhere in the world, simply by accessing the probe through an HTML-5 browser.
- Supports data rates of up to 100Gbps and thus supports 4K production, which means that broadcasters are granted the flexibility to monitor complex and varied network configurations.
- Ensures low latency and exceptional image quality in any given production environment.



Booth : 1.A71



VB330 Appliance

All of the existing functionality that the VB330 provided for other formats has now been extended to the JPEG XS standard, across both appliance and software versions of the probe.

Up to 2000 multicasts using the JPEG XS standard or up to 50Gb of capacity, with the optional 2 * 25 Gb option, can be monitored, with comprehensive deep-dive metrics of the data presented in an intuitive, usable manner; including measurements of bit rate, packet drop, and excess jitter, as well as continuous thumbnail decode for validation of the data.

- TS monitoring and alarming for bitrate and packet loss analysis, and includes thumbnail decode for validation of the content and multicast data from the JPEG XS stream.
- Real-time monitoring.
- Timeline 'content' option has also been extended to cover JPEG XS streams.
- Allows for both thumbnails and measurement metadata to be recorded directly to the appliance for up to four days

The screenshot shows a monitoring interface with a table of services and a 'Detailed Monitoring' window. The table lists services like NRK1 HD, JPEG XS Service, and Accumulated with various metrics. The 'Detailed Monitoring' window shows a table of services with columns for Service/PID, Event log, IAT, Bitrate, Min bitr, Max bitr, CC errors, Thumb, Type, PCR, and Scr.

Service/PID	Event log	IAT	Bitrate	Min bitr	Max bitr	CC errors	Thumb	Type	PCR	Scr
1 JPEG XS			178.846 Mbps	14.336 kbps	318.031 Mbps	139527		MPEG2 SD		
64 JPEG XS Video			169.629 Mbps	0 bps	301.617 Mbps	44079		JPEG XS Video		
96 SMPTE PCM Audio			4.601 Mbps	0 bps	8.199 Mbps	47724		SMPTE PCM Audio		
97 SMPTE PCM Audio			4.601 Mbps	0 bps	8.199 Mbps	47724		SMPTE PCM Audio		
32 PMT			15.096 kbps	14.336 kbps	15.792 kbps	0		PMT		
80 PCR			40.768 kbps	0 bps	78.184 kbps	0		PCR	✓	
Other PIDs			16.600 kbps	15.768 kbps	234.496 kbps	0		Other		



Booth : 1.A71



MVTP HD and MVTP 4K / 8K

Ultra-low-latency video and audio transmissions over long-distance Internet connections for latency-critical applications. Added latency of transmitter and receiver together under 3 ms.

- All-in-one device, fanless, 100% quiet.
- Video up to 1080p60 or 2160p60, 8K version to be available in 2023 as a firmware upgrade.
- Up to 8x 12G-SDI interface for video.
- 8x audio input, 8x audio output.
- Not limited to local network applications, transmission over the worldwide Internet.





MVTP HD and MVTP 4K / 8K

The technology received Europa Nostra Award / Creative Europe Award for support of collaboration in classical music on a European scale.

- Distance collaboration in the performing arts, ultra-low-latency communication.
- Distance master classes, rehearsals, auditions, cultural exchanges.
- Distributed performances with artists in different cities, countries or continents working together in real time for audience in multiple places.



COBALT

Sapphire BBG-2110-H/S & Sapphire BBG-2110-2H

The Sapphire BBG-2110-H/S and BBG-2110-2H mini-converters address the need to display received JPEG-XS content on HDMI monitors in a simple and cost-effective way.

- Mini-converters designed for quiet operation, ideal for mounting behind monitors.
- BBG-2110-H/S: Single-channel unit with simultaneous SDI and HDMI outputs.
- BBG-2110-2H: Dual-channel unit with independent HDMI outputs.
- Dual power supplies for reliability.
- Convert JPEG-XS stream with audio and ancillary data to HDMI.
- Support SMPTE ST 2022-7 Seamless Redundancy up to Class C for WAN operation.
- Compatibility with NMOS IS-04/IS-05 control (in-band and out-of-band).
- Support for popular formats: 720p, 1080i, and 1080p.



SAPPHIRE
CONVERTERS



Booth : 10.F42

COBALT

Sapphire 8JXS-8S

ST 2110 JPEG XS to SDI Bulk Gateway in openGear form factor.

- Dual 25Gb/s Ethernet ports for SMPTE ST 2022-7 seamless switching and supports up to 8 SDI signals, up to 1920x1080p60.
- The card occupies four slots, allowing for up to five cards and 40 signal conversions in a standard openGear chassis.
- Like all Sapphire converters, the card includes full NMOS support for ease of configuration in addition to the standard openGear DashBoard.

SAPPHIRE
CONVERTERS



Booth : 10.F42



VIPS-8K-IP broadcast video server

The VIPS-8K-IP system is simple and stable, supports 8K JPEG XS file, and other encoding formats for file decoding and broadcasting, supports video compression and other external protocols IP stream function, and built-in capability of various types of subtitles insertion.

The final output is a JPEG XS video compressed IP stream and supports ST2022-7 redundancy to ensure the security of the output stream.

The broadcast server can be controlled by third-party control software: file decoding and playback, external signal switching, upper and lower subtitles, and other functions, can be used as a broadcast server, used in the master control broadcast system.





8K IP multi-screen platform product

This product supports signal input of various IP protocols, including ST2110- 22 JPEG XS video compression signal.

It can collect multiple signals for centralized echo monitoring and can monitor and analyze each IP signal in real time.

Thanks to the JPEG XS video encoding, the transmission bandwidth is greatly reduced to meet the input requirements of multi-screen 8-channel 8K signals.

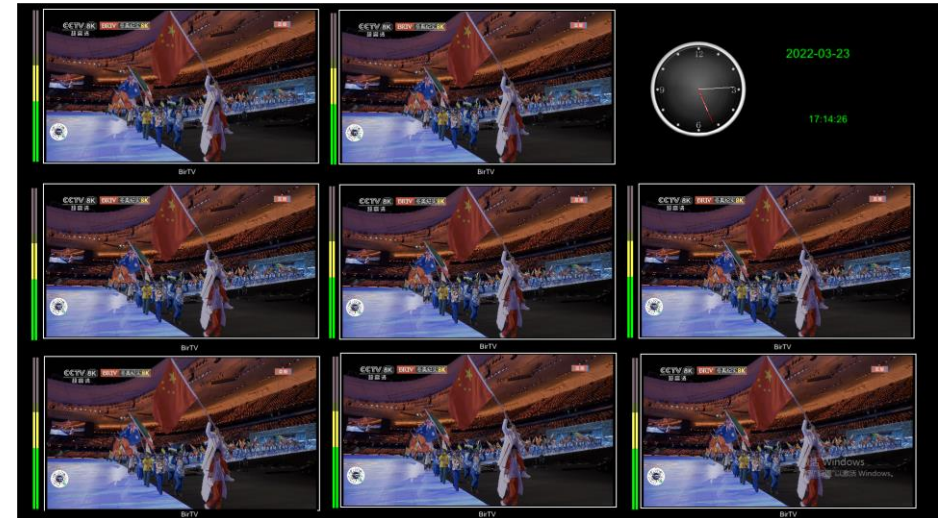

DELTA^ΔCAST

VIDEO SOLUTIONS FOR DEVELOPERS

IP Virtual Card v.1.4

Low-bitrate SMPTE 2110-22 video streaming support in IP Virtual Card with intoPIX JPEG XS Software Development Kit "FastTicoXS".

- Unified SDK for ST 2110 video capture and streaming using standard COTS network cards (NIC).
- Linux and Windows (on x86 architectures), ARM computers
- Offer support from ST 2110-22 streaming at the application level: constant and variable bitrate modes.



Booth : 7.B12



EB82SOC1 – JPEG XS System on Chip Processor

Available exclusively to video equipment manufacturers, the EB82SOC1 “System on Chip” is a software-defined processor for adding multi-channel ST 2110 Encapsulation / De-encapsulation and JPEG XS Encode / Decode (TR 08) to almost any broadcast video product,

- High performance, feature rich, and standards compliant
- NMOS, Ember+, RESTful API, and SPI control interfaces
- Compact and robust package, comprehensive suite of integration tools
- Faster time to market for video equipment manufacturers, dramatically reduced development costs



EB82SOC1
Software-Defined
Video Processor



Booth : 10.A31

STAGE RACER 2

The Stage Racer 2 is a Transmission, Routing, Distribution, Conversion, and Processing unit typically used for live events in Broadcast. JPEG XS codecs enable to optimize the available bandwidth without any visual effects on the video quality.

- Up to 24 SDI (16x3G + 8x12G) on 1RU – JPEG XS codecs on 12G-SDI Ports (x8).
- Genlock, Ethernet, Audio mic/line, AES, MADI, RS, GPIO, Dante / AES-67.
- Meshed topology with reduced latency (few μ s per equipment).
- Standard 10km QSFP, 40km available.
- Audio-video processing (Embedding, De-embedding, Audio shuffling, SRC on all in/out, Frame sync and delays, Embedded Multiviewer).

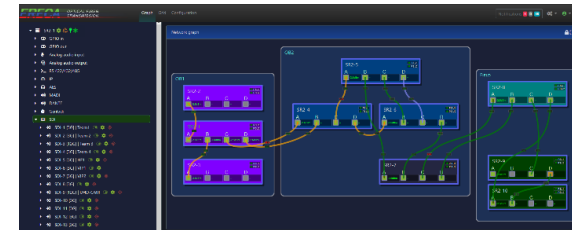
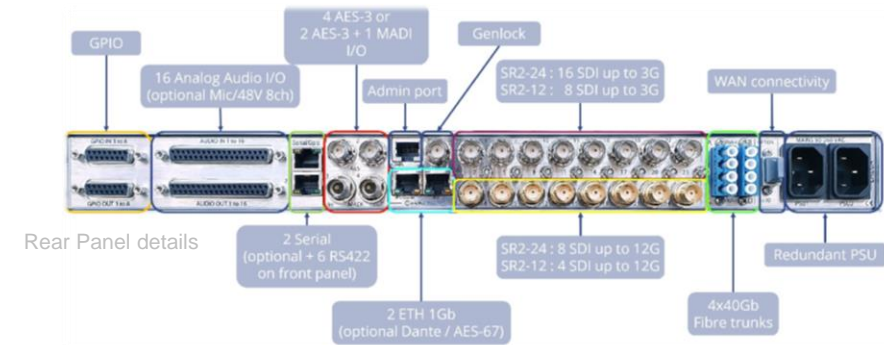

Meshed topology

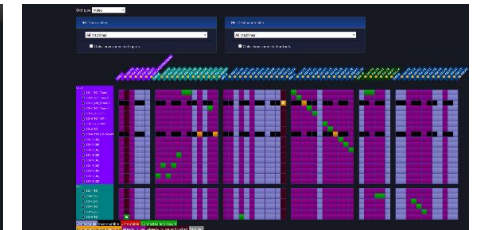

Routing Grid



Booth : 11.C492

STAGE RACER 2

Stage Racer 2 includes up to 8 JPEG codecs which can be activated.

JPEG XS codecs offer the possibility to decrease the required bandwidth for SDI streams and to keep a low latency in order to manage local and also remote production through 10Gb OTN Telco interfaces.

The ultra-low latency achieved allows doing full remote production, including real-time return feeds with no noticeable delay between direct sight and locally displayed studio processed streams.

- Transmission capability on 10Gb OTN (Up to 5x bidi 12G-SDI on a 10Gb Link with TicoXS).
- Low latency and video quality preserved even with compression rates such as 8:1.
- Manage many video formats from HD-SDI to 12G SDI (3840x2160 @ 60 Hz).

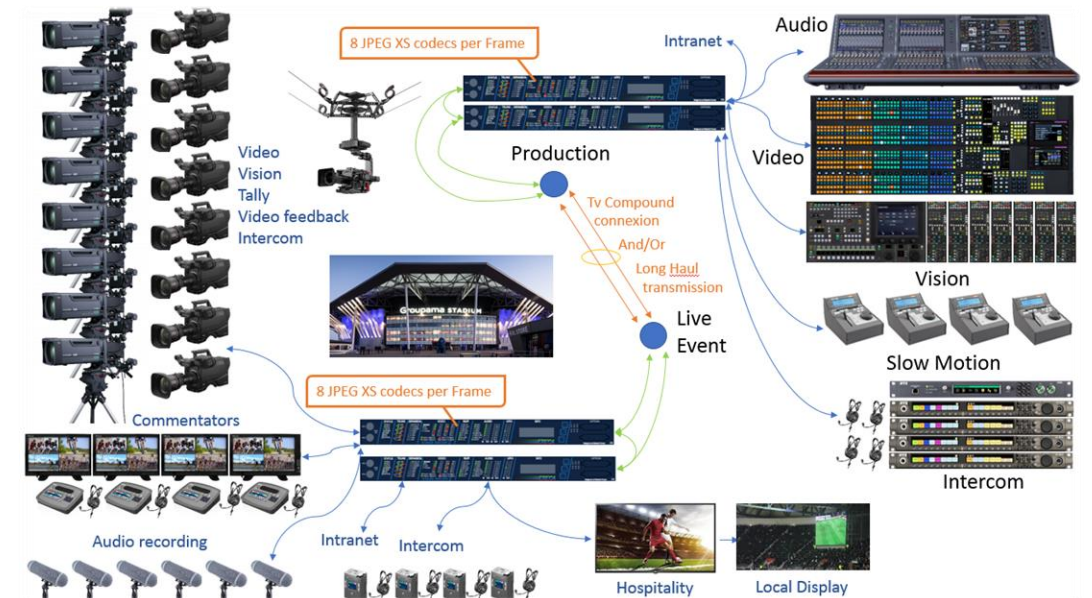

Booth : 11.C49



COMPRESS

Compress is our latest addition to our portfolio of software packages within Neuron. Compress is our a high density transcoder software option which can be deployed on the Neuron software defined hardware.

- SDI, IP, or hybrid IO.
- Up to 48 encoders/decoders up to FHD in 1 RU @240Watts.
- Up to 24 encoders/decoders on UHD in 1 RU @240Watts.



Booth : 10.A25

FilmLight

FilmLight REMOTE with integrated JPEG XS

Complete remote color grading solution providing true high-quality, low latency monitoring.

- Makes remote creative image manipulation and monitoring truly possible.
- Integrated JPEG-XS encoding and decoding ensures a high-quality, low latency video stream to the remote end where a FilmLight desk service also provides support for a control surface.
- Includes support for multiple UI monitors, mouse, and keyboard as well as control surface.

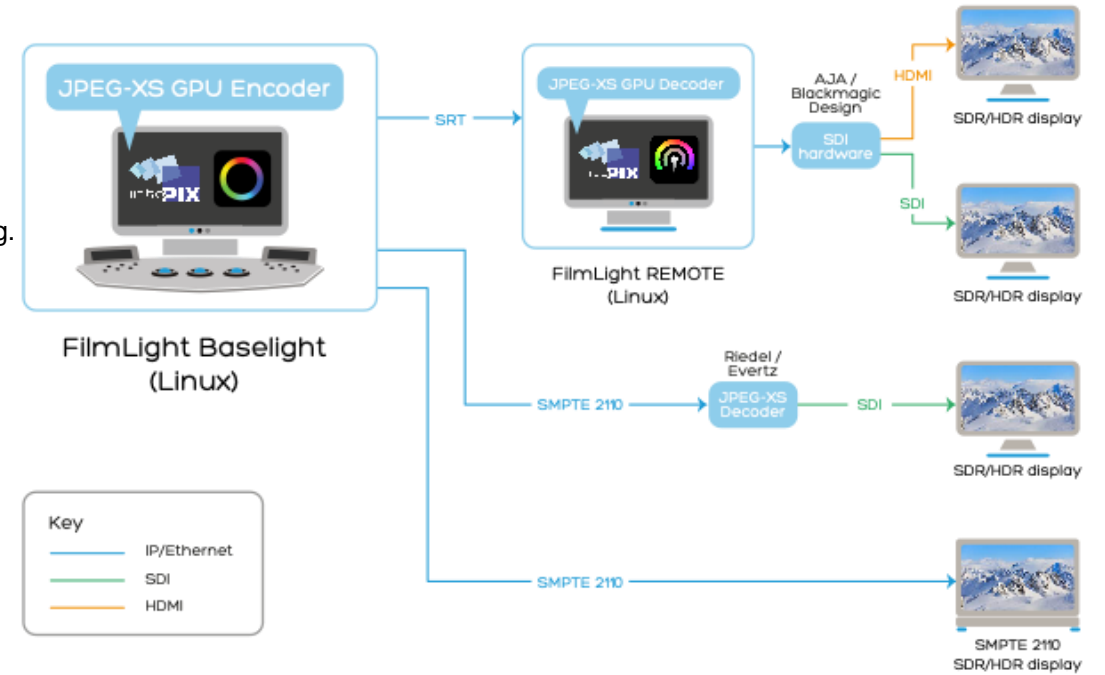



LDX 100 Series Cameras

5x JPEG XS codecs are integrated in the camera head and can be activated via a software option. Compression ratio can be selected between 5:1 and 20:1.

- Reduces bandwidth requirements for remote productions and reduces network cost.
- Ultra low latency, offers uncompromised operation in any live applications.
- Integrated encoding reduces the amount of external equipment, is easier to set up, and minimizes latency.
- Full redundancy from the camera to the IP network, for improved security.

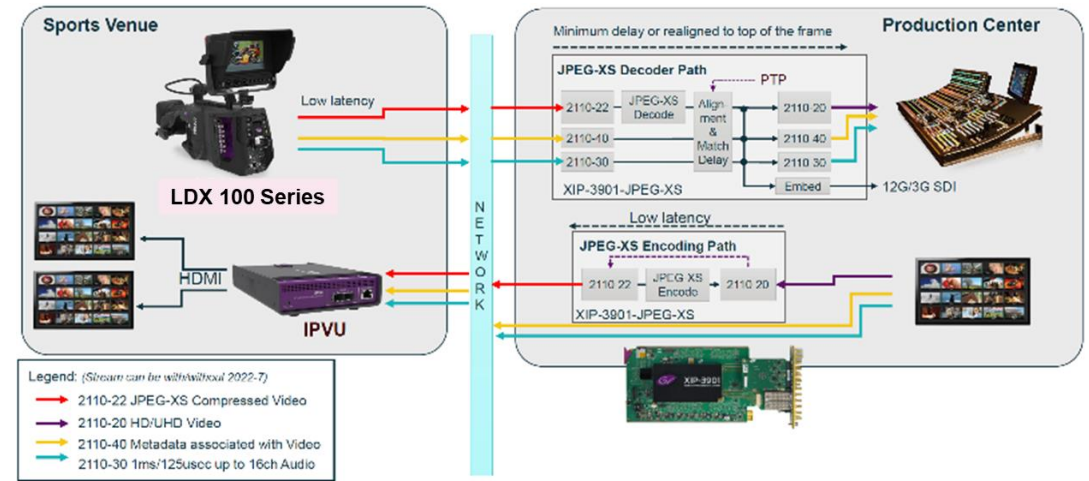

Booth : 9.A01



Remote application with LDX 150 Cameras

NEP The Netherlands, used 5x LDX 150 cameras with integrated JPEG XS encoding for a remote production between Beijing and Hilversum.

- Reduction in the number of people who had to travel.
- Signals from the remote site could be easily integrated with the locally generated signals.
- Fully redundant IP connection for highest security.

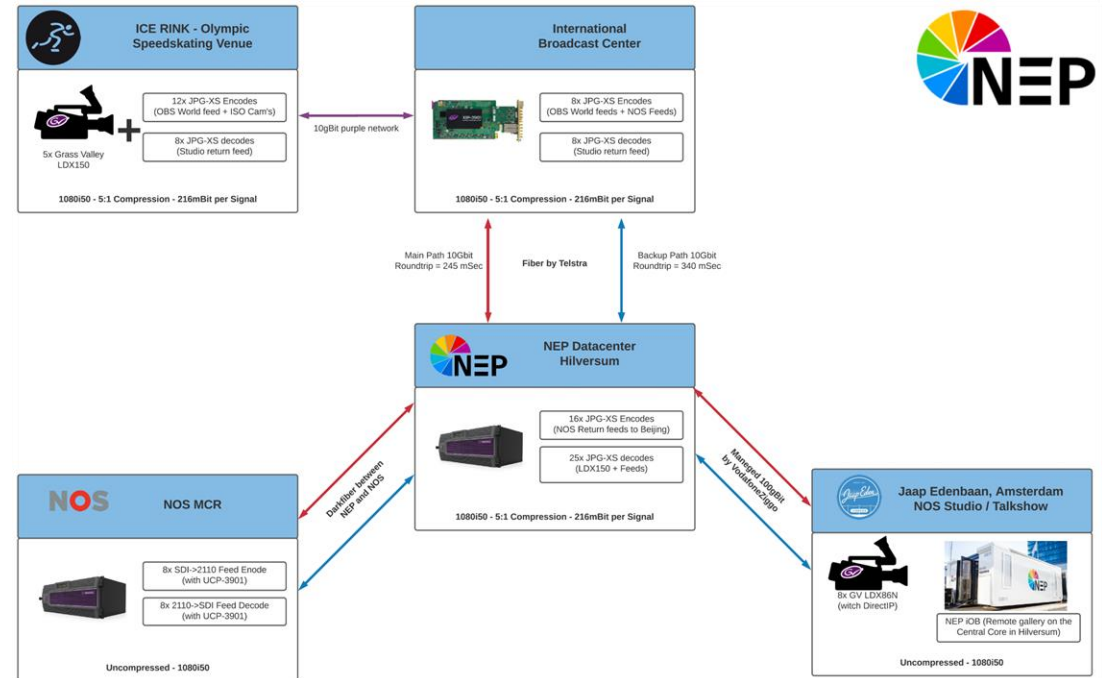

Booth : 9.A01



Selenio Network Processor (SNP)

Imagine's SNP is a complete HD/UHD/HDR video processing toolkit, that includes JPEG XS encoding and decoding support (VSF TR-08 and VSF TR-07).

Each SNP can perform up to 32 1080p JPEG XS encodes or decodes, with SDI or 2110-20 or 2022-6 inputs and outputs for uncompressed signals, and VSF TR-08 for JPEG XS.

- JPEG XS allows users of the SNP to link facilities with production-quality video signals – and easily interchange between in-plant ST2110-20 and inter-facility TR-08.
- This allows lower-cost 10G circuits to carry dozens of HD signals between sites.

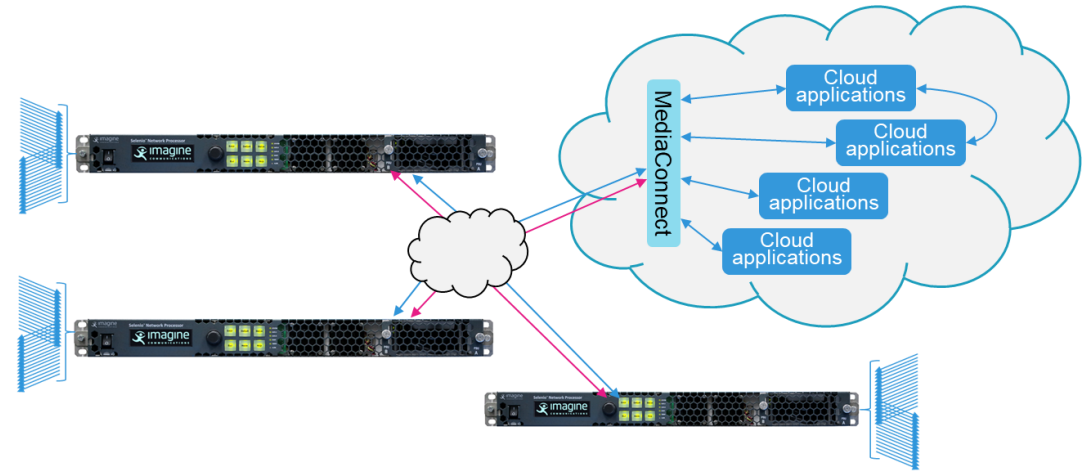

Booth : 2.A15



JPEG XS HDMI2.0 Cyclone® 10 GX FPGA Dev Kit

Intel Cyclone 10 GX FPGA is the first low-cost device built on a high-performance 20 nm process, offering a performance advantage for cost-sensitive applications.

- Low-cost way to evaluate JPEG XS in FPGA, which requires only a single Intel Cyclone 10 GX Development Kit + HDMI 2.0 FMC daughter card.
- Simple evaluation scheme requiring only one board to implement JPEG XS encode-decode loopback.
- JPEG XS IP by Intel partner intoPIX leverages the ease-of-use and productivity enabled by Intel FPGA Video and Image Processing IP Suite.
- Full Intel end-to-end solution: use the same JPEG XS video codec in your embedded FPGA design using the intoPIX hardware IP and in your Intel CPU design using the intoPIX software development kit (SDK).

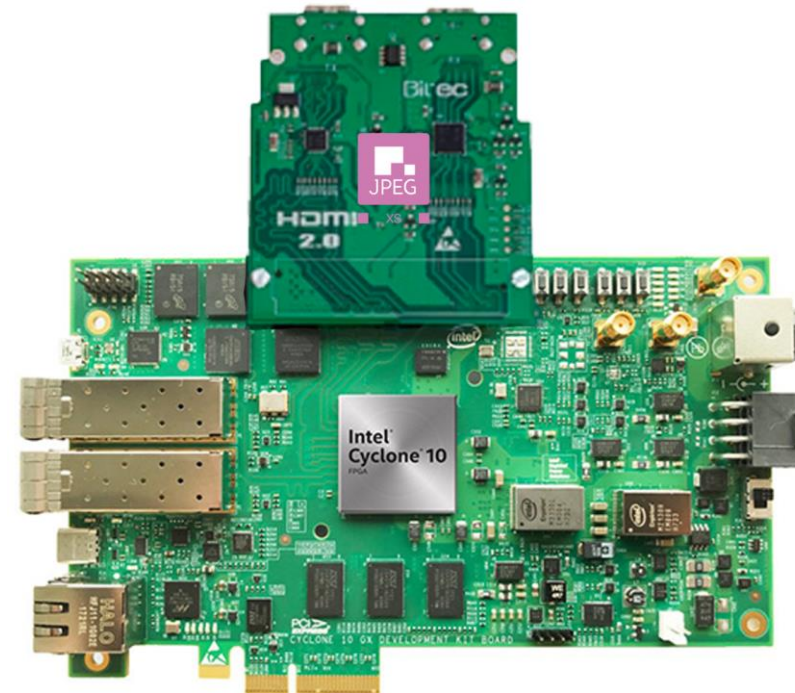



HOME Apps – Server-based Processing Platform

Purchasing bespoke hardware that may be obsolete faster than we like is turning into a potentially costly gamble.

Meet Lawo's HOME Apps—the abstraction of broadcast and media functionality from the hardware that does the compute heavy lifting. When you need it, where you need it, with a revolutionary commercial model.

- Cater to all formats and requirements (HD, 3G, 12G) at the click of a button.
- Mix and match the SMPTE 2110, JPEG XS, NDI® and SRT protocols on a single network.
- JPEG XS compression ratios: 5:1 – 36:1, visually lossless up to 10:1
- Decide for yourself whether and how much to invest upfront.
- Remain nimble despite tight budget control.
- One overarching solution for private data centers and public clouds caters to the building blocks of your processing infrastructure.

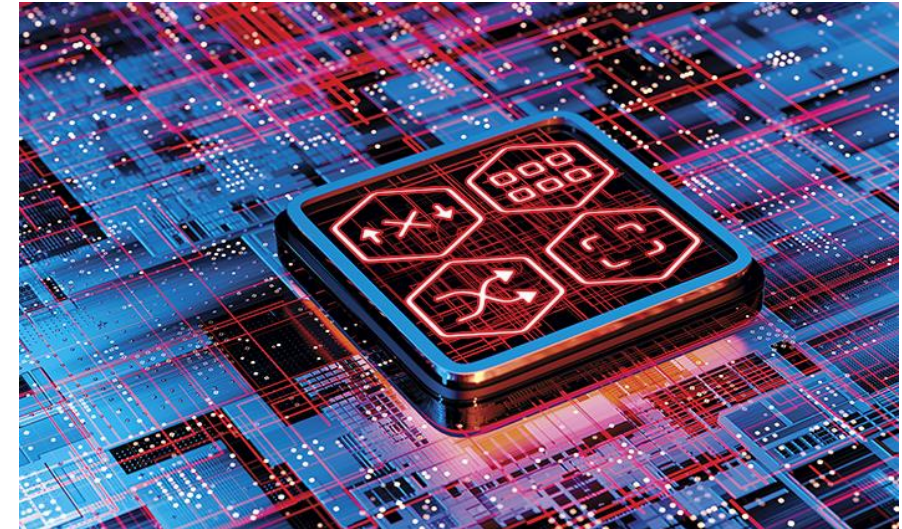

Booth : 8.B90



JPEG XS License for Lawo .edge

An edge computing application for bandwidth-critical remote workflows, this software-licensable option for new and existing .edge users provides broadcast-grade support for JPEG XS compression encoding and decoding. A maxed-out .edge unit with .jpegxs licenses offers an impressive number of ultra-low-latency HD/3G and UHD instances that run alongside .edge's existing SDI input functionality, including audio shuffling as well as licensed add-on options.

- Up to 20:1, reduces overall infrastructure and IP network congestion at source
- Enables remote workflows thanks to highly efficient, lossless compression via WAN and LAN
- Multi-format capable: HD, 3G and UHD with HDR support (8K-ready)
- Industry-grade interoperability: support for SMPTE ST2110-22 and NMOS
- Built-in decoding downscaler



Booth : 8.B90

MACNICA

MPA1000 Module / ME10 SoC

The Macnica MPA1000 is the IPMX system on a module based on Macnica's ME10 SoC that allows AV over IP manufacturers to design IPMX-compliant equipment that converts HDMI to 1GbE IPMX.

- HDMI 2.0 over 1GbE IPMX.
- Super-low latency with high-quality visually lossless video.
- Full stack solution with RESTful API, customizable web application, and scripting environment for additional features and functionalities.
- Launch Kit available for evaluation and development.



Booth : 2.A58



ConvertIP

ConvertIP enables the latest **IP video workflows**: ST-2110, IPMX and JPEG XS. Its applications include encoding, displaying, monitoring, and transmitting compressed and uncompressed IP and baseband signals.

- Adopt ST 2110 IP video workflows
- ST 2110 monitoring and conversion – 1GB, 10 GB, 25GB - HDMI
- Broadcast production using SDI and live signal routing/management
- Flexible – Daisy Chain + PoE



Booth : 7.B15

MediaKind

Beam RX1 & CE1

Experience Unmatched Broadcasting Efficiency: MediaKind's Beam Integrates intoPIX JPEG XS, for the Highest Quality, ultra-low latency encode, decode, and transcode.

- Achieve low-latency video contribution with visually lossless quality.
- Utilize JPEG XS light compression in a pure software environment.
- Achieve PSNR measurements exceeding 50dB using MediaKind Beam SW encoding.
- Reduce power consumption by up to 40%.



Booth : 1.D25



JPEG XS App for the Nimbra 600

Cost effective and ultra-reliable JPEG XS processing for 1/10gbe ip media.

Compact JPEG XS encoding and decoding of HD and UHD-4K media. JPEG XS is the perfect replacement or complement to fully uncompressed workflows. Combine the JPEG XS App with any of the other Nimbra virtual functions to build your IP media network.

- Relied upon for national contribution of mission-critical services and major global sports events.
- Alternative or complement to uncompressed video for all ST2110 and SDI workflows.
- Add UHD-4K workflows while saving bandwidth but not making quality or latency compromises.
- Ultra-low, millisecond level, encode-to-decode latency with 85% to 95% bandwidth savings.



Booth : 1.B41



Media Pro App with JPEG XS for Nimbra 600

Combine safe IP networking, protected data workflows, and JPEG XS in one application. JPEG XS encoding and decoding is now available for Net Insight's award-winning media pro app family with IP media trust boundary. This fully open and standards-based IP media product aggregates, monitors, and protects all media and data workflows. The latest function update allows users to use ultra-low latency JPEG XS compression to reduce bandwidth and infrastructure costs.

- Compress UHD-4K or HD video to/from JPEG XS with ST2110, SDI or VSF TR-07 handover
- Combine video compression with other media flows and data services in one application
- Safely and reliably connect IP networks to other IP networks using SMPTE RP-2129
- Control all flows including JPEG XS compressed flows, with AMWA NMOS IS-04/05

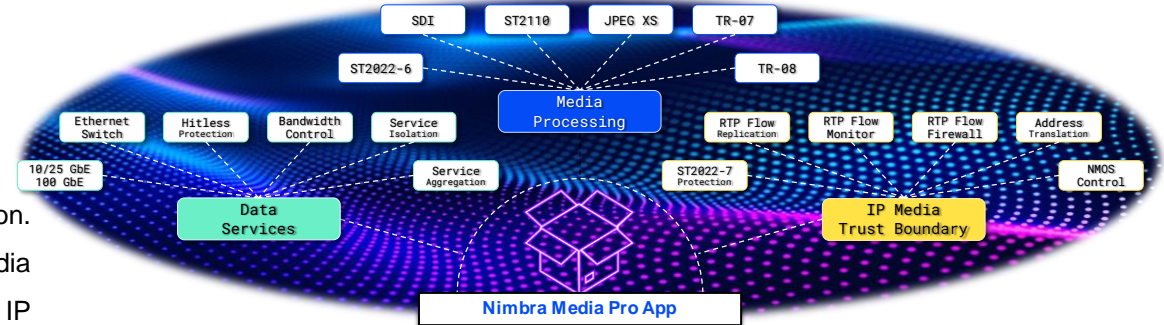

Booth : 1.B41



JPEG XS App for the Nimbra 1000

Cost-effective and ultra-reliable JPEG XS processing for 100gbe IP media.

Combine Nimbra 1060's high density 1.2Tbps media networking with JPEG XS encoding and decoding of HD and UHD-4K media. JPEG XS is the perfect replacement or complement to fully uncompressed workflows. Combine the JPEG XS App with any of the other Nimbra virtual functions to build your 100GbE IP media network.

- Relied upon for national contribution of mission-critical services and major global sports events
- Alternative or complement to uncompressed video for all ST2110 and SDI workflows
- Add UHD-4K workflows while saving bandwidth but not making quality or latency compromises
- Ultra-low, millisecond level, encode-to-decode latency with 85% to 95% bandwidth savings



Booth : 1.B41



Media Pro App with JPEG XS for Nimbra 1000

Combine safe ip networking, protected data workflows and jpeg xs in one application.

100GbE JPEG XS encoding and decoding is now available for Net Insight's award-winning Media Pro App Family with IP Media Trust Boundary. This fully open and standards-based IP media product aggregates, monitors, and protects all media and data workflows. The latest function update allows users to use ultra-low latency JPEG XS compression to reduce bandwidth and infrastructure costs.

- Compress UHD-4K or HD video to/from JPEG XS with ST2110, SDI or VSF TR-07 handover
- Combine video compression with other media flows and data services in one application
- Safely and reliably connect IP networks to other IP networks using SMPTE RP-2129
- Control all flows including JPEG XS compressed flows, with AMWA NMOS IS-04/05

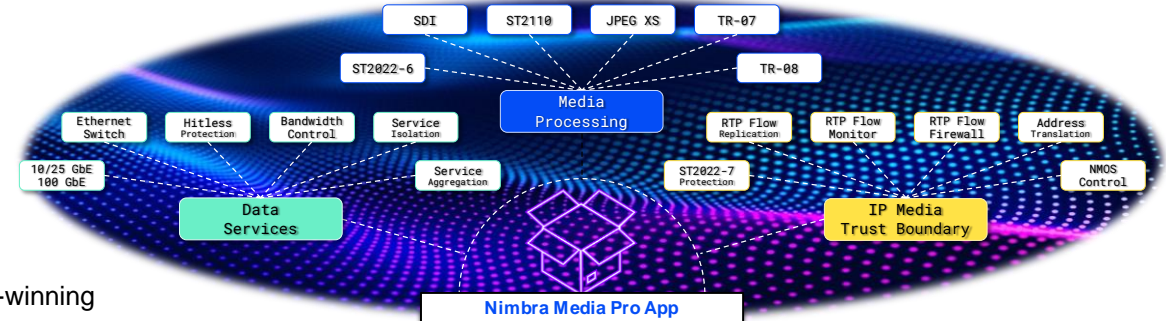

Booth : 1.B41



Nevion Virtuoso

Widely deployed across the globe, Virtuoso is a standards-based, virtualization-ready, software-defined media node that can perform a variety of real-time functions in the converged IP LAN/WAN network.

The world's first live deployment of JPEG XS (2019).

- Functionality easily modified in the field through software.
- Offers adaption (SDI/ST2110/ST2022-6), transport protection (e.g. ST2022-7), video encoding/decoding (e.g. JPEG XS), UDC, audio processing, audio mixing, IP media edge and much more.
- JPEG XS: SDI and ST2110 (10GE/25GE) in/out, up to 32 HD channel or 16 UHD channel encoding/decoding in one 1RU appliance.





NVIDIA Rivermax SDK compliant with intoPIX FastTicoXS SDK

NVIDIA Rivermax is a unique IP-based solution for media and data streaming applications that leverages NVIDIA Ethernet NICs.

Interfacing with intoPIX FastTicoXS SDK, it can handle the streaming of low latency compressed JPEG XS SMPTE 2110-22 video.

- Safeguards all advantages of an uncompressed stream such as ultra-low latency, and high quality.
- Offers a significant bandwidth reduction with real-time GPU encoding/decoding in HD, 4K, or 8K.
- Turnkey solution for developers to support the new JPEG XS standard.

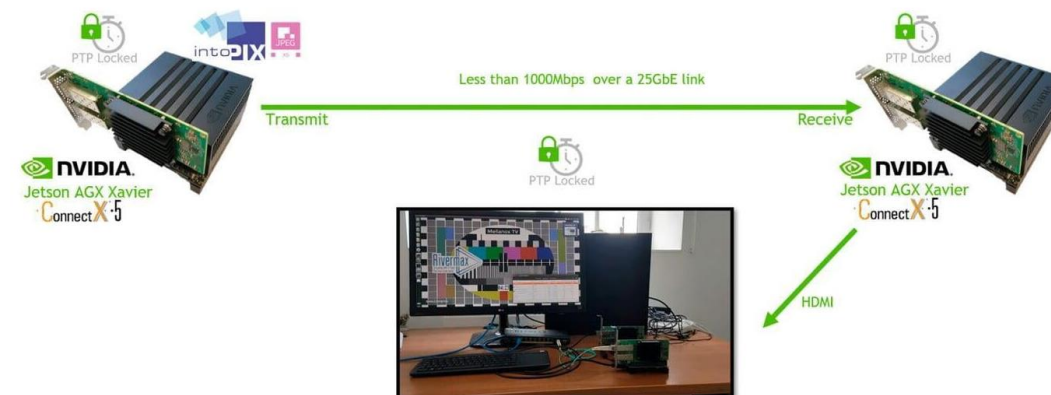

Panasonic CONNECT

AK-PLV100GSJ

4K PL-mount Studio Camera for Live Cinematic Video with Shallow Depth of Field.

- Equipped with a large format, 5.7K Super 35mm sensor, and PL Lens mount to accommodate cinema lenses for shallow depth of field.
- SMPTE ST2110 output (HD: Uncompressed, 4K: JPEG XS) is possible directly from the AK-PLV100GSJ camera head without connecting to a CCU*, enabling IP-based live production with just the camera, doing away with the need for complicated systems.
- Support for JPEG XS is planned for the third quarter of CY2023.

Powered by
VARICAM Super35



Booth : 2.G102

Panasonic CONNECT

AW-UE160W/K

New generation 4K PTZ Camera for an era of enhanced creativity and the pursuit of visual expression

- Uncompromising shooting performance and operability including high sensitivity of F14/2000 lx, phase detection autofocus, and optical low-pass filter for moiré reduction.
- Realize next-generation video production with various shooting methods and functions including ST 2110, JPEG XS*, 2x high speed output, and 5G mobile router.
- Stress of shooting on-site can be reduced with various IF/protocol support including NDI and SRT and waveform and horizontal level gauge display functions.
- The optional software key AW-SFU60 is required to activate ST 2110 and JPEG XS on the AW-UE160W/K. JPEG XS support is planned by the end of CY2023.



Booth : 2.G102

PROVIDIUS

Broadcast Media Guard (BMG)

The BMG can acquire, decode, and analyze a wide variety of media flows (including JPEGXS) across multiple high-capacity IP interfaces (up to 100Gb/s) simultaneously. Zero-footprint software that provides precision network packet timing analysis trusted by engineering, operations, and system integrators.

- Simultaneous decoding and monitoring of multiple media types including JPEG XS
- 24/7 real-time monitoring, capable of monitoring by exception notification
- NMOS IS-04/IS-05 support for network discovery and patch management
- VM or bare metal deployments accessed anywhere using secure web UI



Booth : 11.B05



MuoN B - IP ST2110 JPEG-XS Encode/Decode

Miniature SFP-based converter capable of encoding or decoding two HD/3G/UHD signals. 32 IP ST2110 native converters can be housed inside the VirtU-32 (1RU) frame for a total of 64 converters.

- Optimized exchange of multiple signals between sites.
- Reduce bandwidth transmission of UHD signals without compromising quality.
- Lowest footprint in the market with 64 converters in a single RU space.
- Highly modular and low failure blocks.

VirtU-32 housing frame



MuoN B
Software-Define SFP converter



Booth : 10.A31



Fusion 3B/6B – Edge JPEG-XS Encode/Decode

Miniature edge device converters capable of encoding or decoding two HD/3G/UHD signals using JPEG-XS (TR-08). The modular I/O frame allow the support of SDI, HDMI or fiber optical I/Os.

- Optimized exchange of multiple signals between sites
- Reduce bandwidth transmission of UHD signals without compromising quality
- Can be installed at the back of a monitor to provide direct JPEG-XS decoding to HDMI or SDI output
- Can be used near remotely located equipment removing the need for additional extenders



Fusion 3B
Software-Defined
Edge converter



Fusion 6B
Software-Defined
Edge converter



Booth : 10.A31

SONY

NXLK-IP50Y

SDI-IP converter board.

- Eight 1.5/3G-SDI bi-directional ports plus dual SFP28 (25Gb Ethernet) ports including network connection redundancy.
- Compatible with ST 2110-20/30/40 streaming formats and offering very low latency signal conversion.
- Ideal for integration in real-time IP Live production environments.

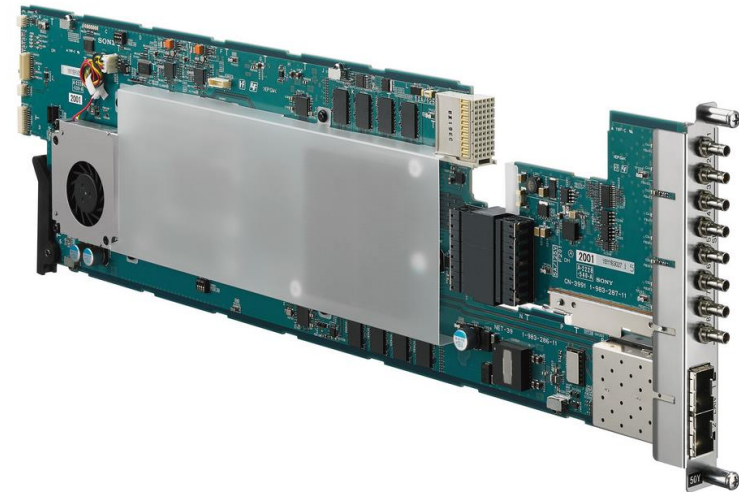

Booth : 13.A10

SONY

NXLK-IP51Y

SDI-IP converter board

- Two 1.5/3G-SDI bi-directional and two 12G-SDI x2 bi-directional ports, plus dual SFP28 (25Gb Ethernet) ports including network connection redundancy.
- Compatible with ST 2110-20/30/40 streaming formats and offering very low latency signal conversion
- Ideal for integration in real-time IP Live production environments.

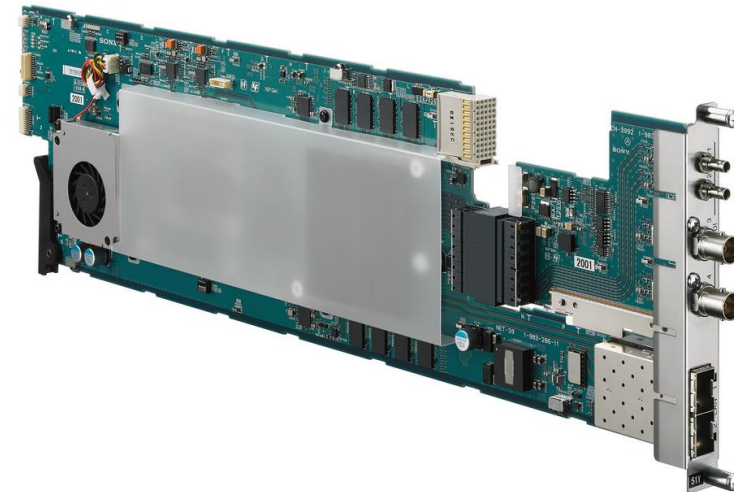

Booth : 13.A10

SONY

HDCE-TX30

IP camera extension adaptor.

- Reduces the cost and complexity of remote production.
- Simplifies the connection of Sony HDC 3500/3100 and HDC-2500/2400/1700 series system cameras to an SMPTE ST 2110 IP network.



Booth : 13.A10

SONY

HDCE-TX50

IP camera extension adaptor

- Reduces the cost and complexity of remote production.
- Simplifies connection and dual transmission capability for Sony HDC-5500/5000 and HDC 3500/3100, HDC-2500/2400/1700 series system cameras to an SMPTE ST 2110 IP network.



Booth : 13.A10

SONY

BVM-HX3110

30.5-inch TRIMASTER HX™ Master Monitor

- High Luminance, Deep Black, Accurate & Wide Color Reproduction, Wide Viewing and Optional Fast Pixel Response Function.
- With a standard IP interface for SMPTE ST2110 signals, the BVM-HX3110 complements Sony's Networked Live ecosystem.
- Optional tool sets support for JPEG XS and SNMP.



Booth : 13.A10



VICO-XI

VICO-XI enables conversion “IP to IP”, between uncompressed ST2110-20 IP streams and JPEG XS compressed ST2110-22 IP streams of 4K and HD video. The 1RU chassis can host up to two 4K channels.

- A cost-effective and single-box solution, ready for integration within your IP studio, OBVAN, or IP remote site.
- A single 1RU, equipped with hot-swappable redundant power supplies.
- Controllable through front-panel, web interface, SNMP, and support NMOS.





VICO-4L-XS

VICO-4L-XS enables JPEG XS visually-lossless conversion of 4K SDI video signals into ST2110-22 JPEG XS stream, with ST2022-7 redundancy. The 1RU chassis can host up to two 4K channels.

- A cost-effective and single-box solution, ready for integration within your IP studio, OBVAN, or IP remote site.
- A single 1RU, equipped with hot-swappable redundant power supplies.
- Controllable through front-panel, web interface, SNMP, and support NMOS.





VICO-8L-XS

VICO-8L-XS enables JPEG XS visually lossless conversion of 8K SDI video signals into ST2110-22 JPEG XS stream, with ST2022-7 redundancy. The 1RU chassis can host up to two 8K channels.

- A cost-effective and single-box solution, ready for integration within your IP studio, OBVAN, or IP remote site.
- A single 1RU, equipped with hot-swappable redundant power supplies.
- Controllable through front-panel, web interface, SNMP, and support NMOS.



8K JPEG XS Codec Adapted for SMPTE ST 2110

JPEG XS achieves visually lossless quality with 10:1 compression for 8K video transmission. It enables dual stream transmission of 8K 60Hz over 10GbE.

Due to the very high bitrate, the 8K production systems used to be large-sized and complicated.

- JPEG XS technology reduces the cable counts for 8K transmission
- JPEG XS scalable function is useful for 4K & 8K simultaneous productions
- The I/O interface conforms to ST 2110 and can be connected to various devices

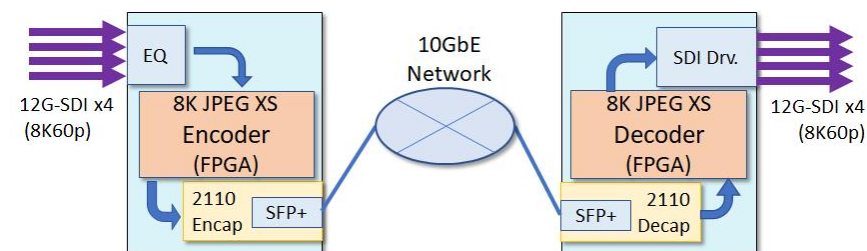
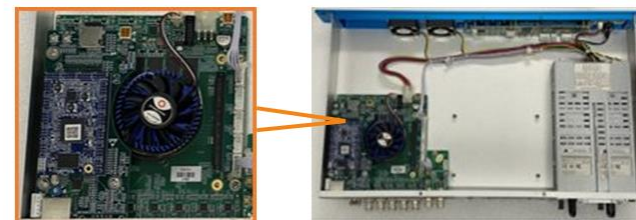



Xscend IP Media Platform

All new ultra-dense, ultra-versatile 2RU IP Media Platform capable of transporting up to 128 contribution quality media services across both managed and unmanaged IP networks.

Xscend's adaptable, software-defined, media-tuned architecture accommodates ever-evolving advances in:

- Network Protocols
- User Defined Workflows
- Physical Interfaces
- Compression Codec Algorithms
- Video Formats

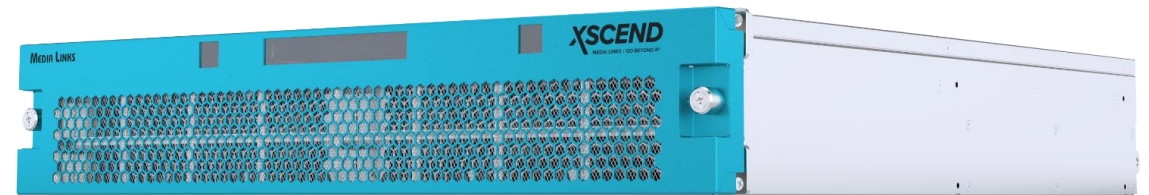

Booth : 1.A59